

Repasa o número 4 e conta os cans e coloreaos

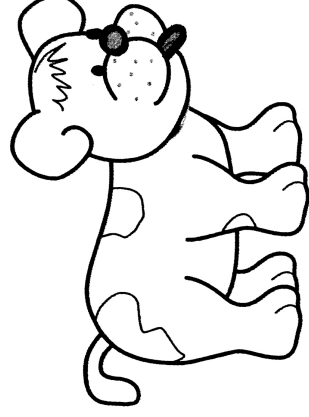

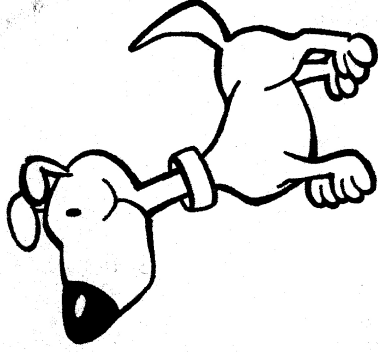

Fai o número catro con gometas e pinta catro caretas

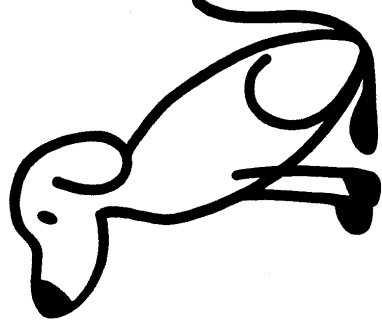
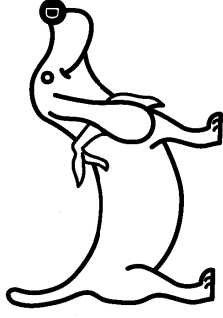
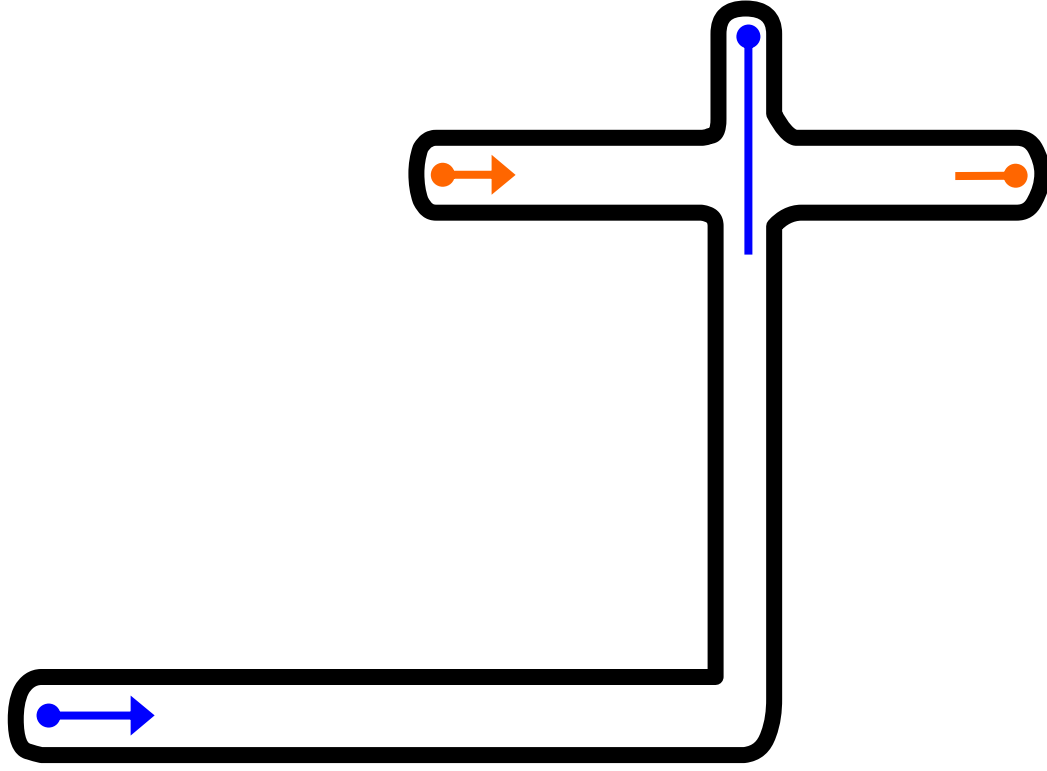
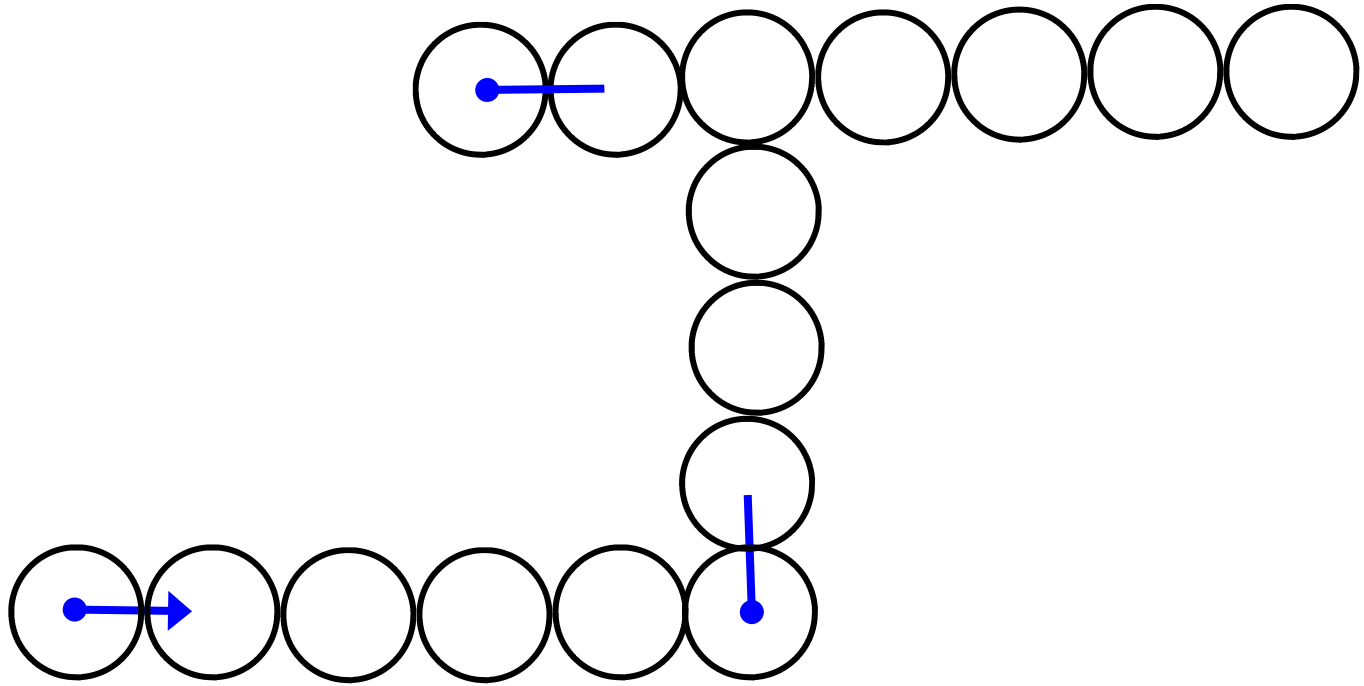
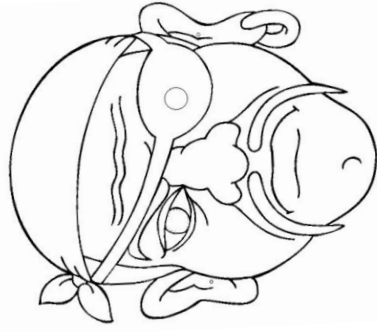
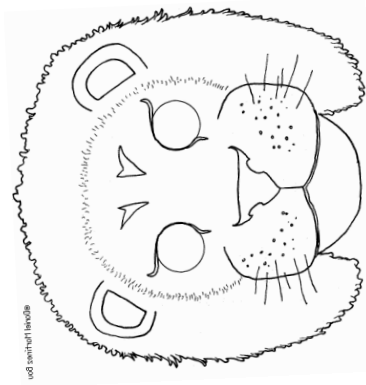
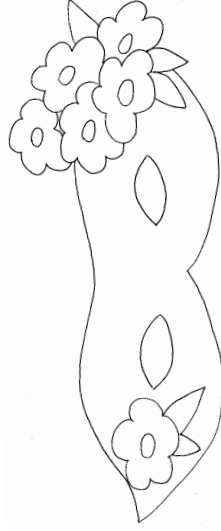
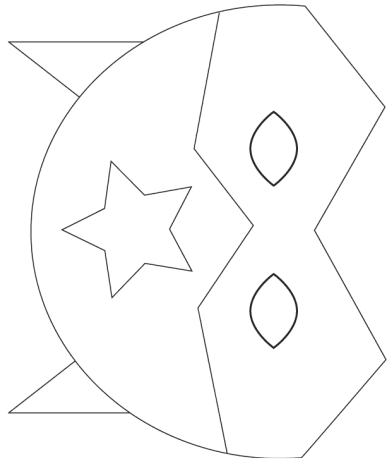
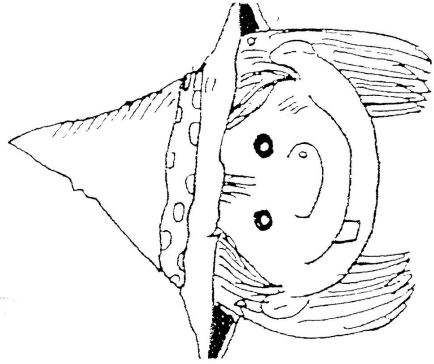

Repasa e número 4

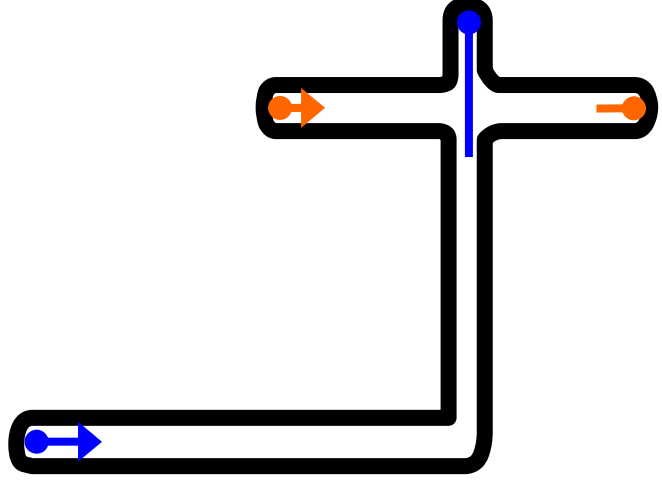
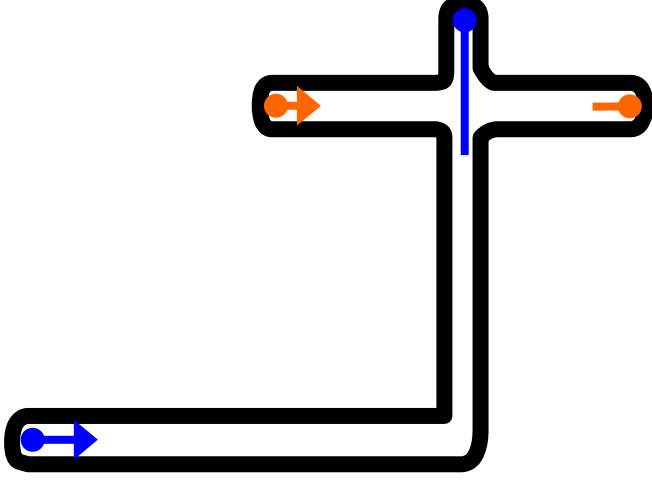
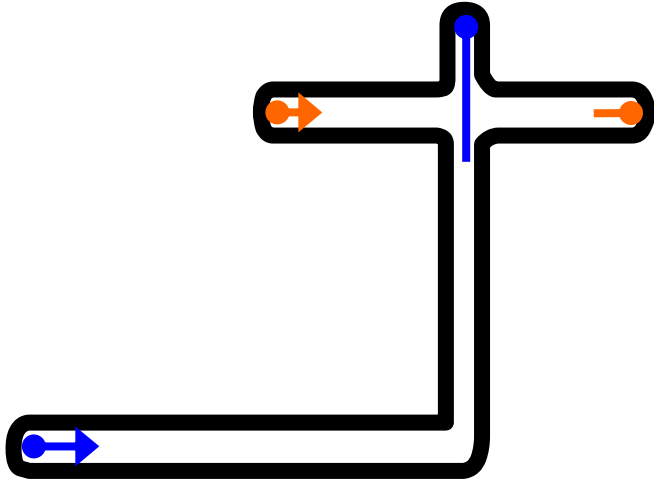

Repasa o número 4 e colore as catro estrelas

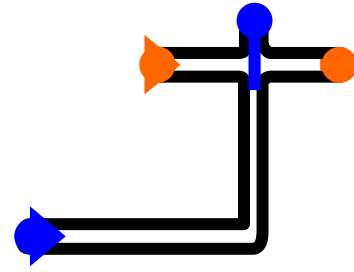
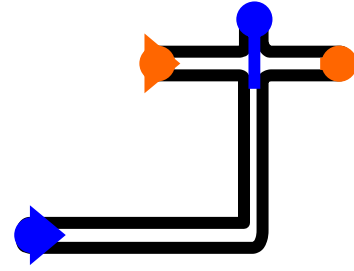
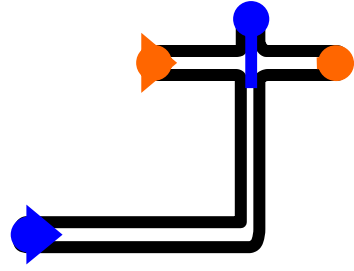
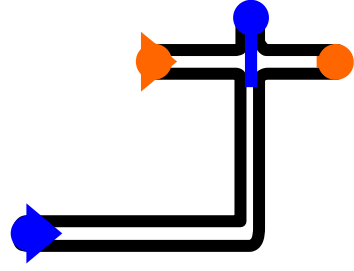
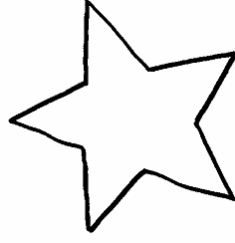
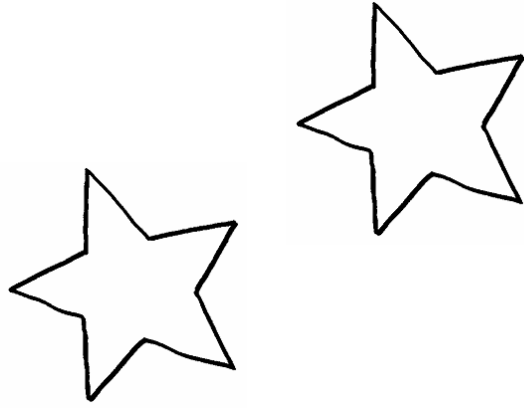
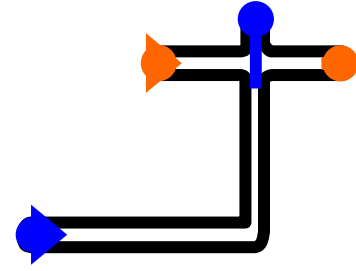
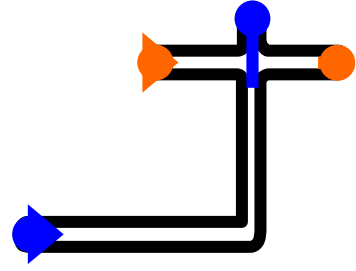
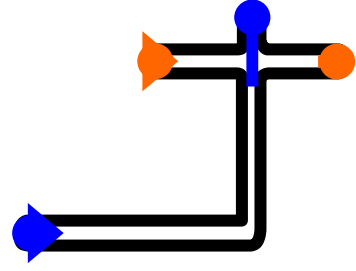
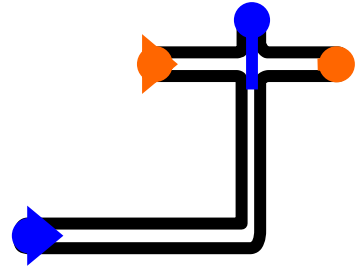

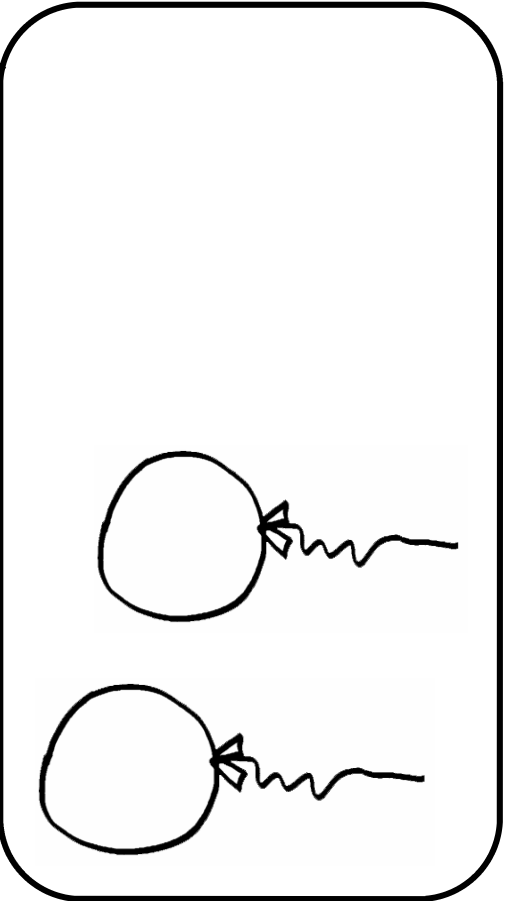
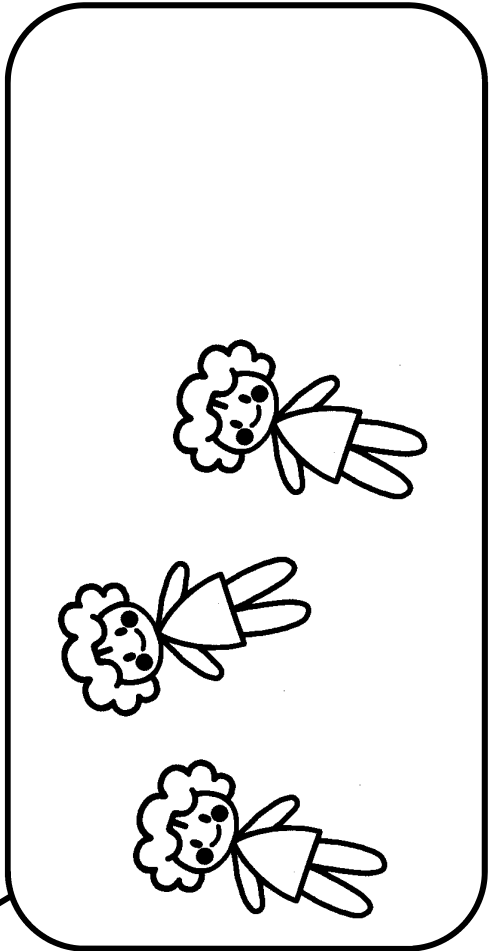
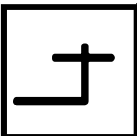
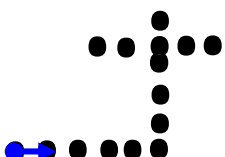
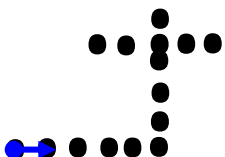
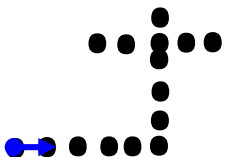
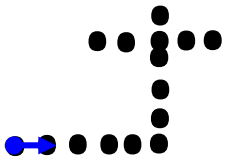
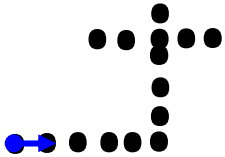
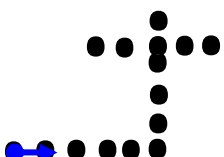
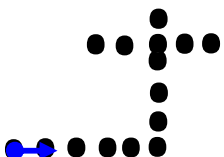
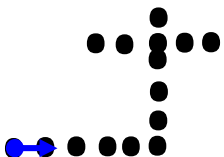
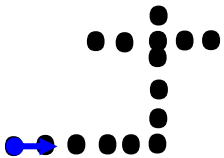
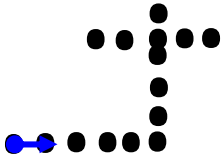

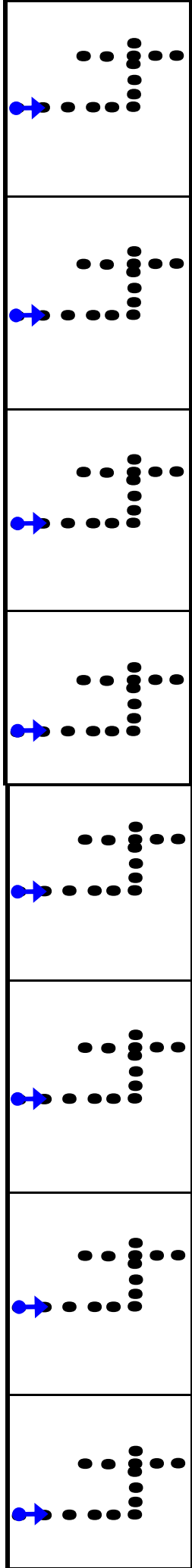
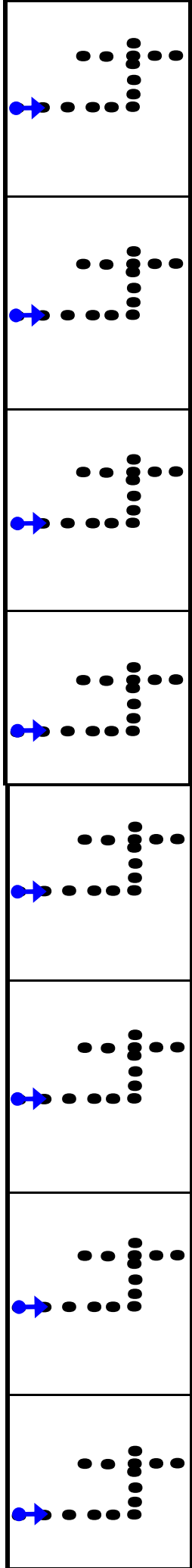

Rodea os antifaces de catro en catro e pintaos

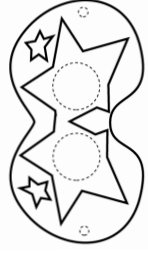
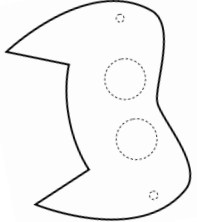
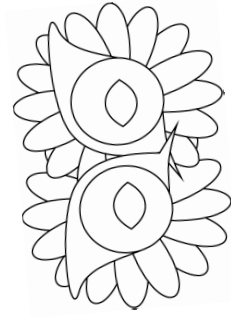
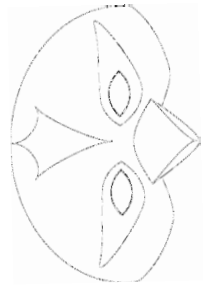
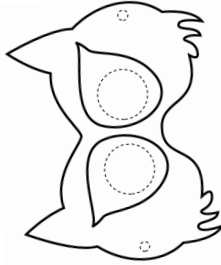
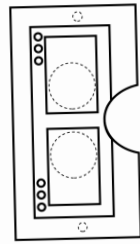
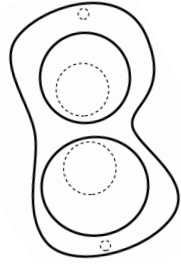

Repasa o número 4

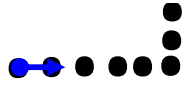
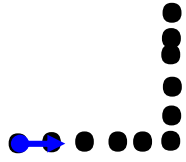
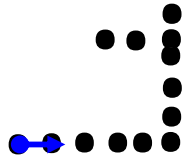

Desuxa 4 peisaiños

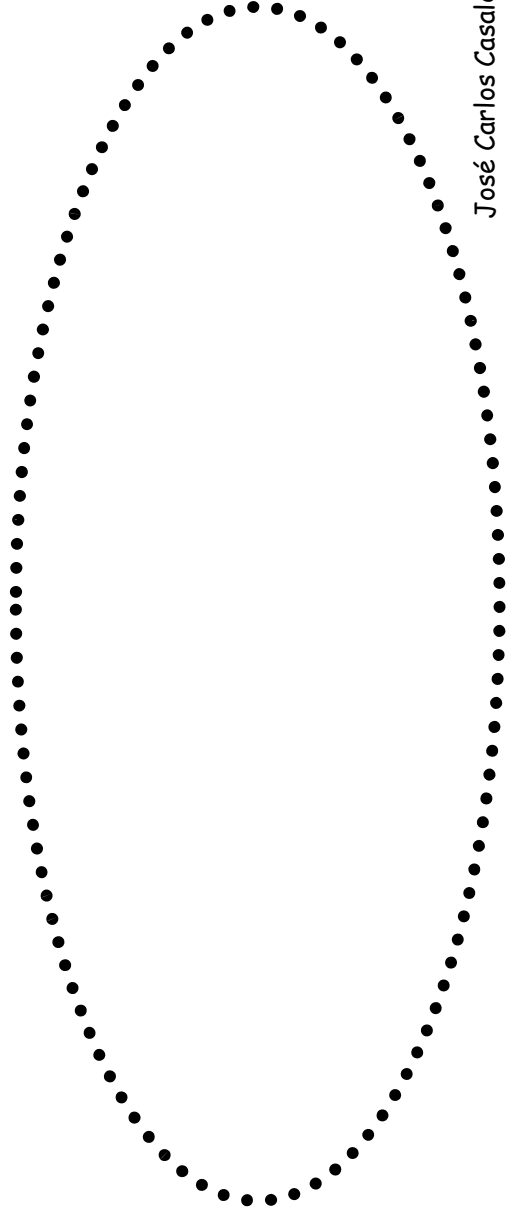

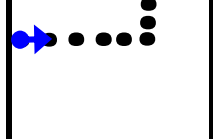
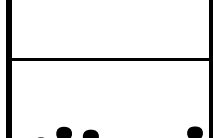
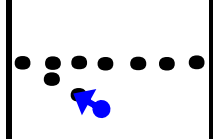
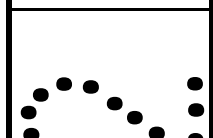
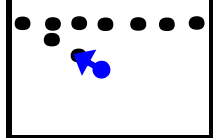
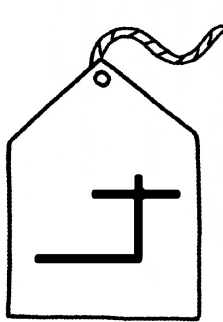
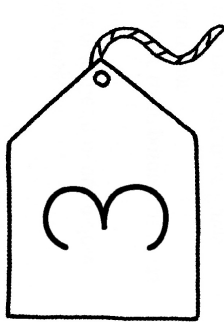
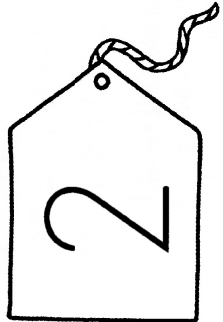
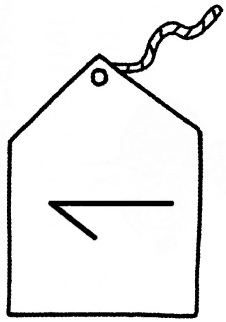
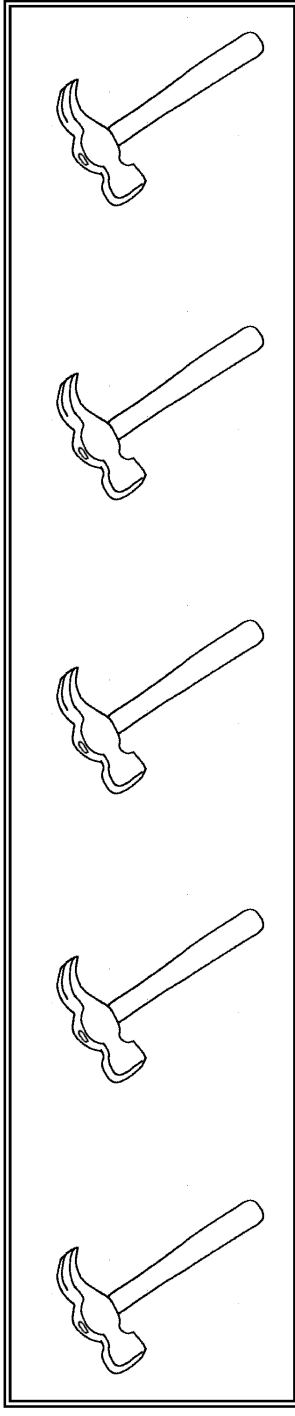
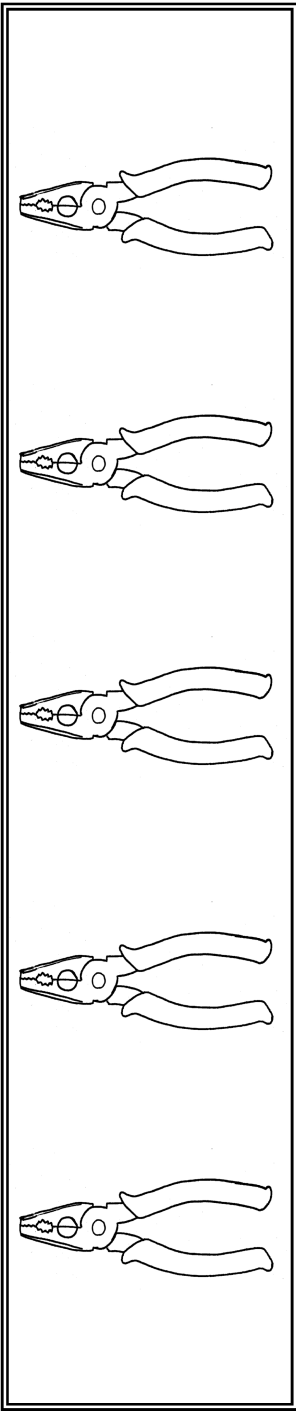
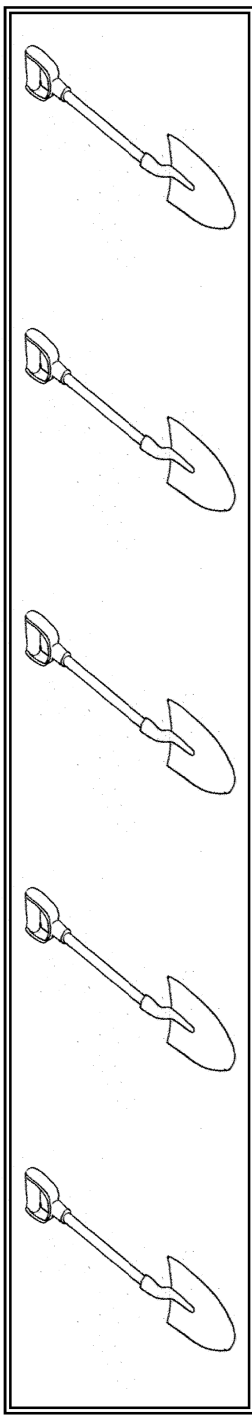
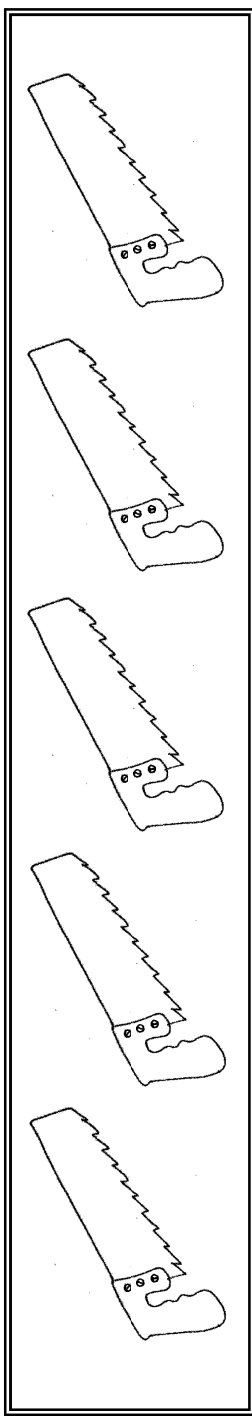

Pinta o número de cousas que marca a etiqueta e repasa

Conta e escribe cantos xoguetes hai en cada conxunto. Repasa a serie numérica

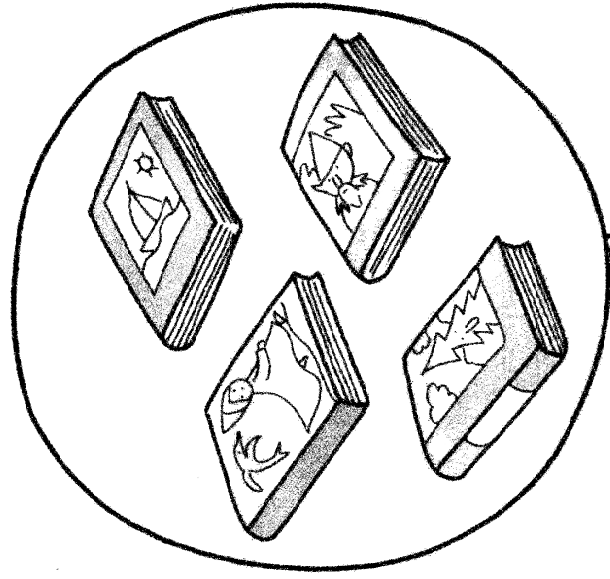
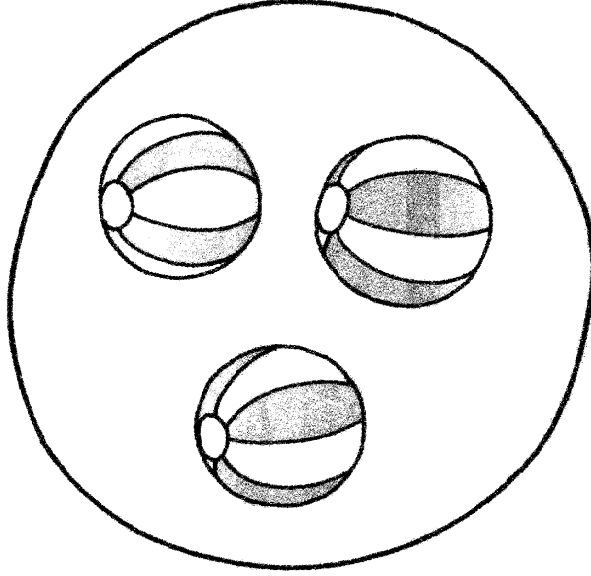
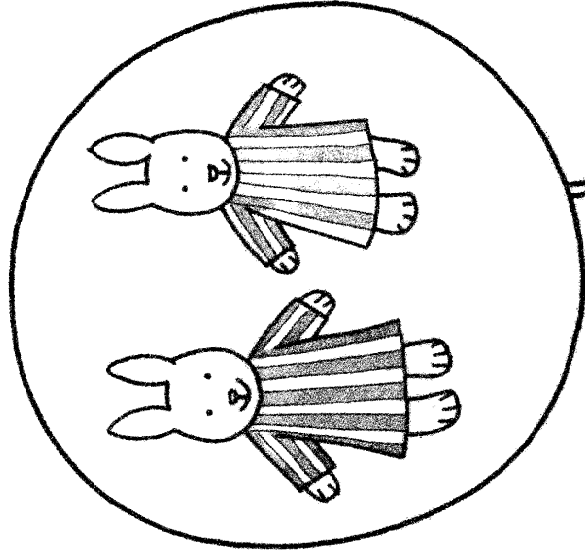

--	--	--	--	--	--	--	--	--

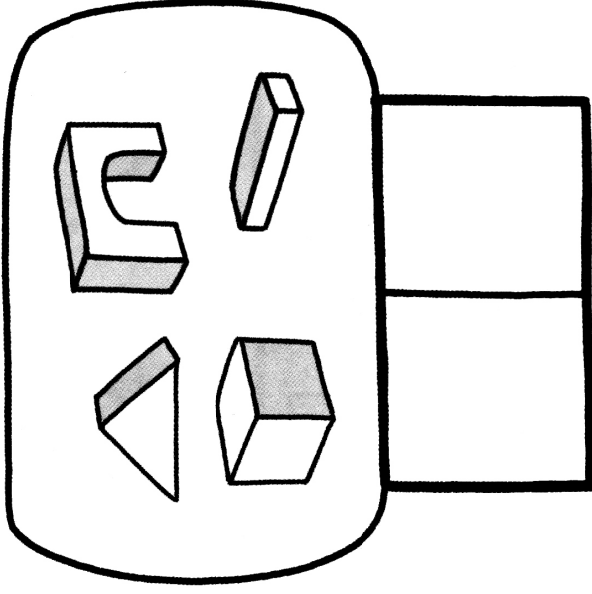
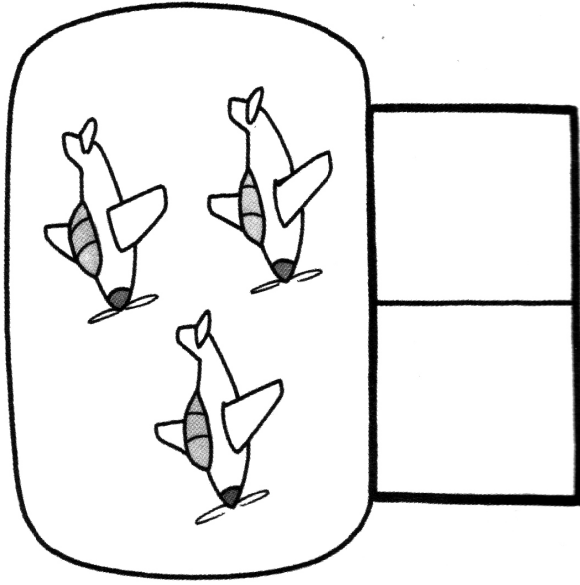
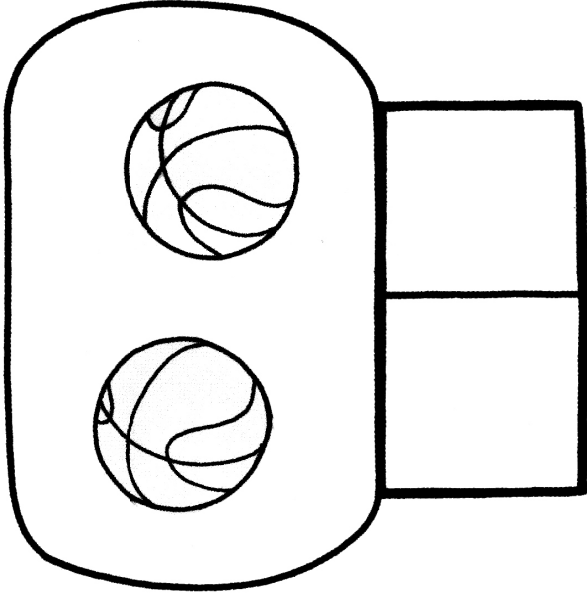
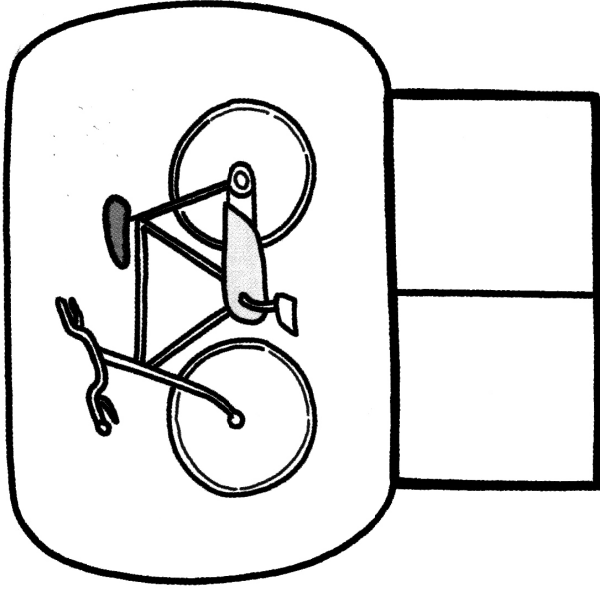
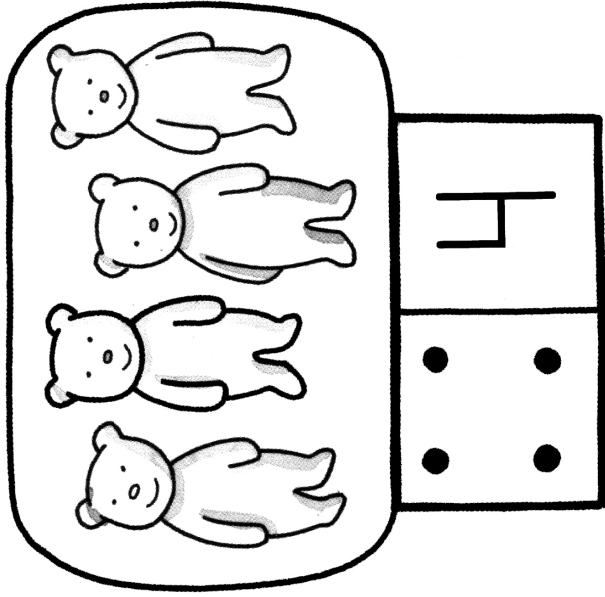

Facer tantos puntos como xoguetes hai en cada conxunto. Poñe-lo cardinal

Escribe cantos cousas hai en cada conxunto

